

2. Silbe lesen (Lesestufe 1.1)

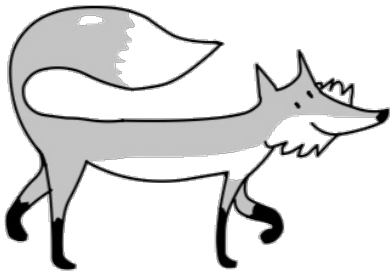

La

Le

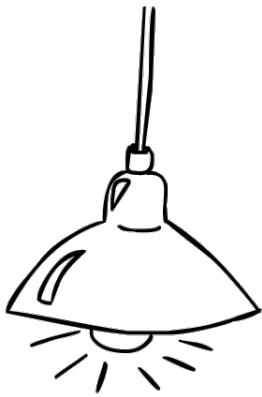
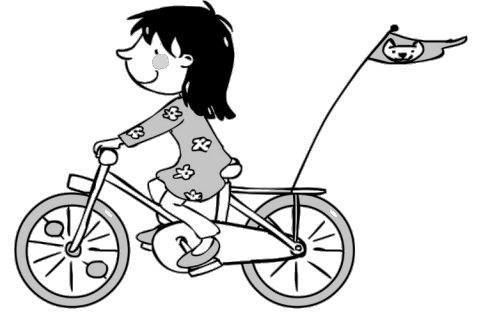

Fu

Ma



Fo

fa

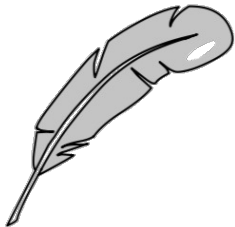

Fe

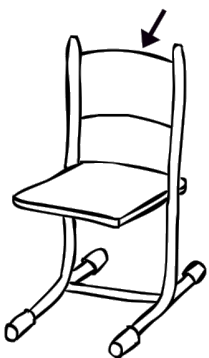
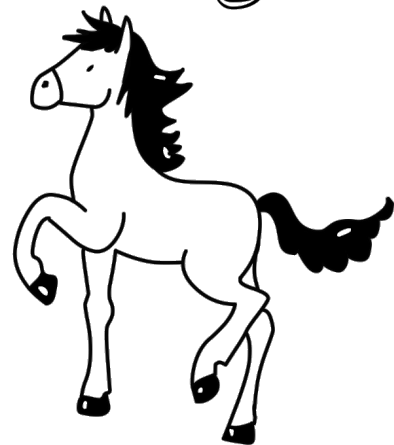

Li

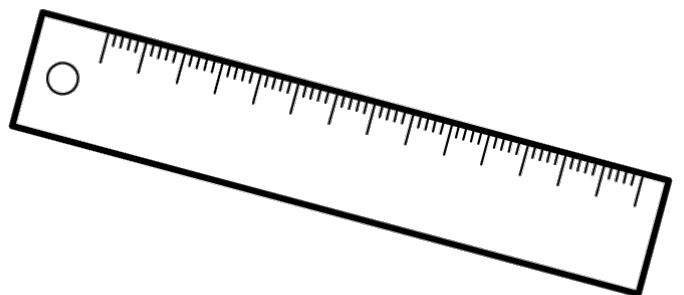

Fuchs, Lampe, Feder, Lehne

fahren (Fahrrad), Mama, Fohlen, Lineal

2. Silbe (oder Anfangsbuchstaben) schreiben (Lesestufe 1.1)

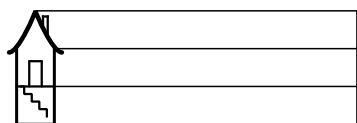
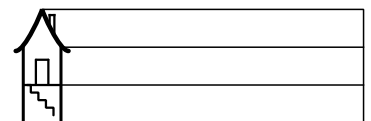
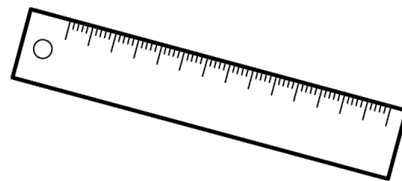
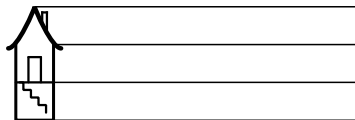
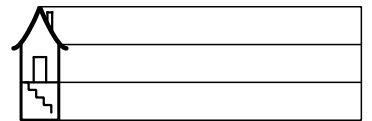
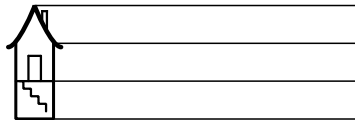
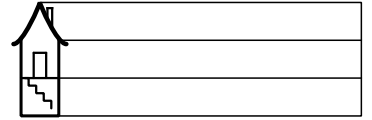
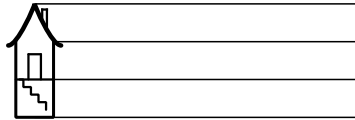
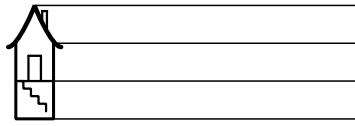
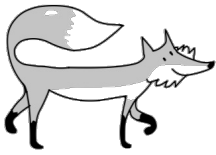

Fuchs, Lampe, Feder, Lehne

fahren (Fahrrad), Mama, Fohlen, Lineal

2. Silbe lesen - Memory (Lesestufe 1.1)

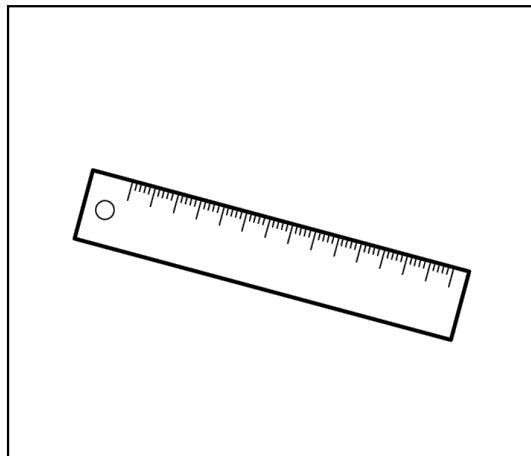
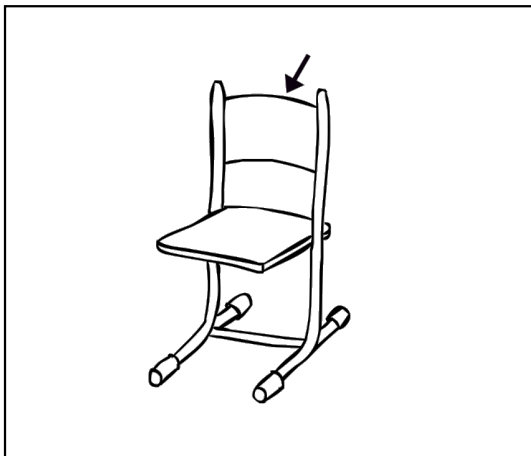
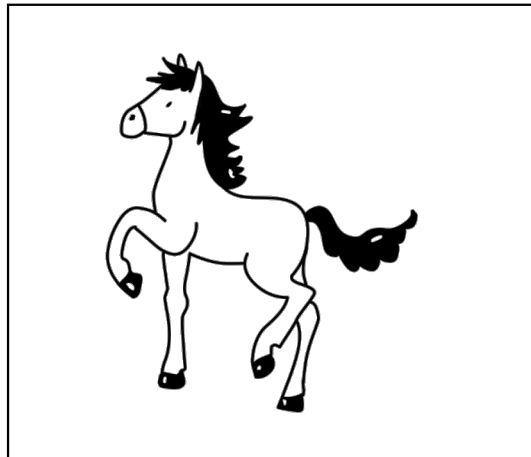
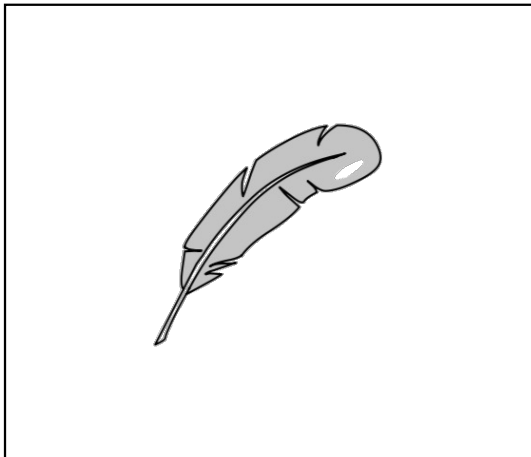
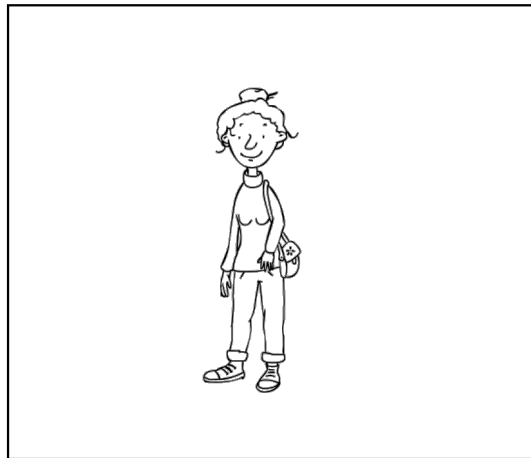
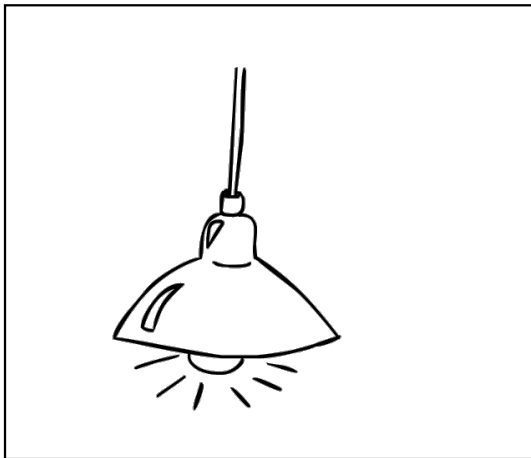
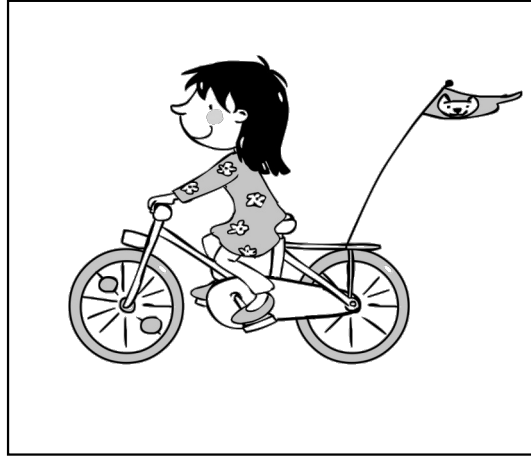
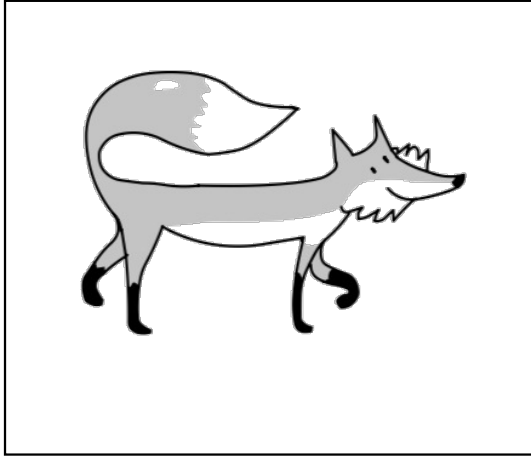

fahren (Fahrrad), Mama, Fohlen, Lineal

Fuchs, Lampe, Feder, Lehne

2. Silbe lesen - Memory (Lesestufe 1.1)

Fu

La

Fe

Le

fa

Ma

Fo

Li

fahren (Fahrrad), Mama, Fohlen, Lineal

Fuchs, Lampe, Feder, Lehne

2. Wörter schreiben (Wortmaterial Lesestufe 1.1)



Lampe



Feder



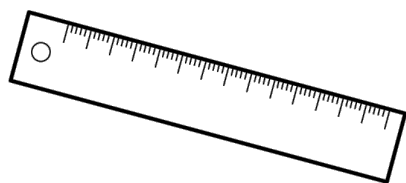

Mama





Lineal

 Lampe Lampe Lampe

 Lampe Lampe Lampe

 Lineal Lineal Lineal

 Lineal Lineal Lineal

 Feder Feder Feder

 Feder Feder Feder

 Mama Mama Mama

 Mama Mama Mama

 Lampe

 Lineal

 Feder

 Mama

2. Purzelwörter (Wortmaterial Lesestufe 1.1)

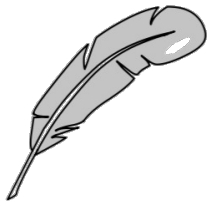

F d e e r

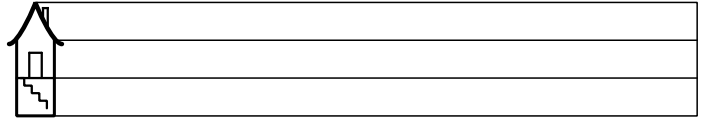

s l e n e

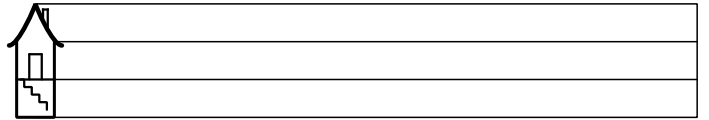

l e L i n a

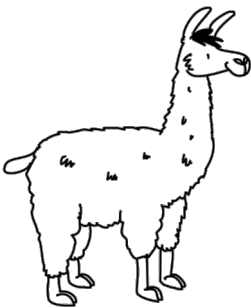
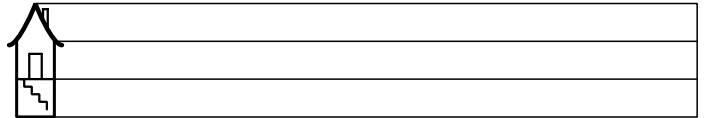

a L m a

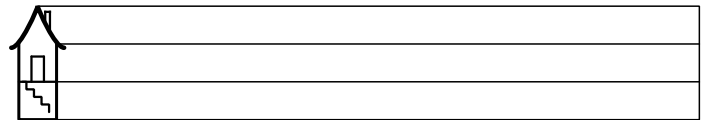

e L m a p

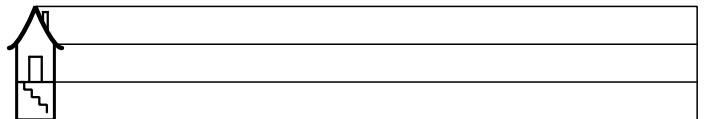

a M a m

